

RAZOR CREST™

レイザー・クレスト/レイザー・クレスト(シルバーコーティングVer.)

※①→②の順番で組み立てましょう。
*Assemble in numerical order ①, ②, ...

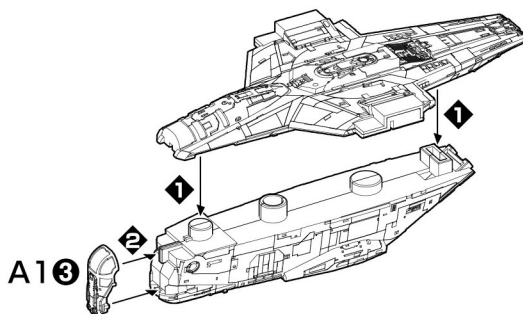
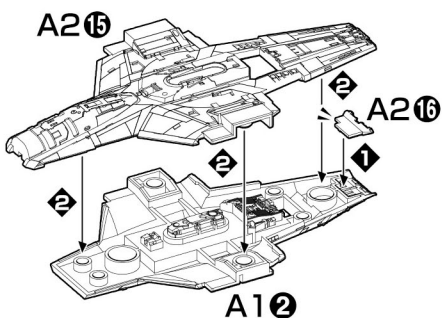
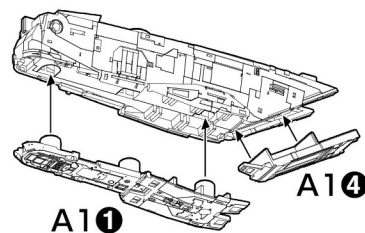
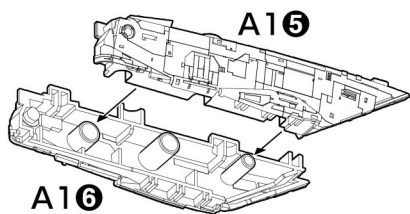

ENGINE A

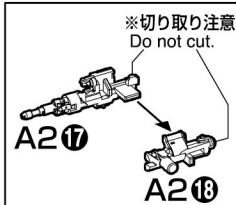
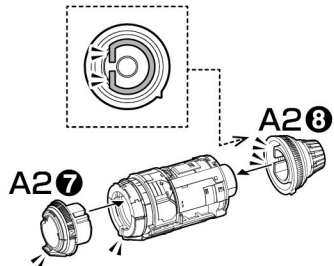
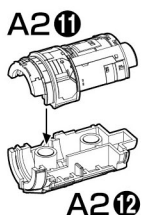

ENGINE A

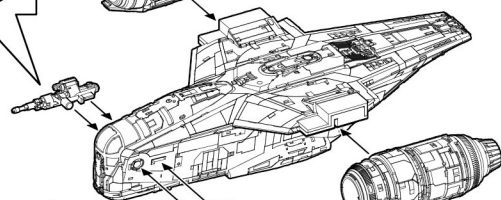

ENGINE B

ENGINE B

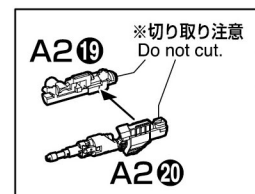
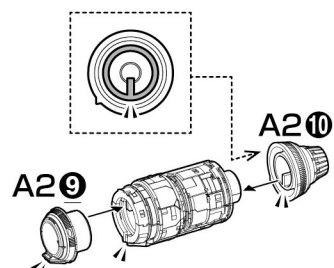
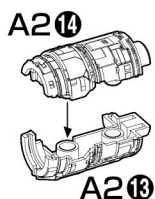

選んで取り付けます。
Select a position to attach.

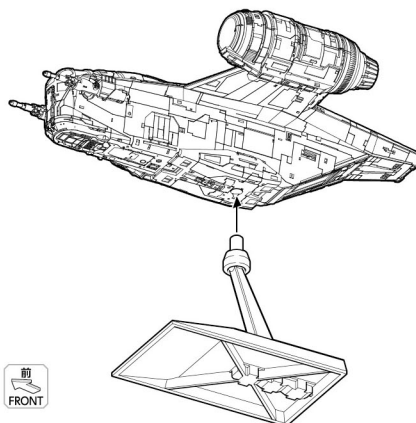
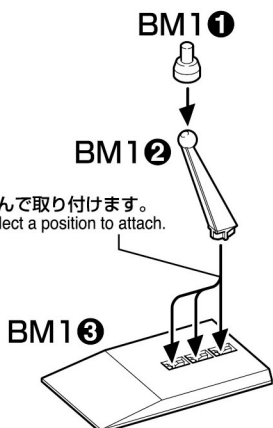

Plastic Model Kit
RAZOR CRESTTM
SILVER COATING Ver.
レイザー・クレスト(シルバーコーティングVer.)

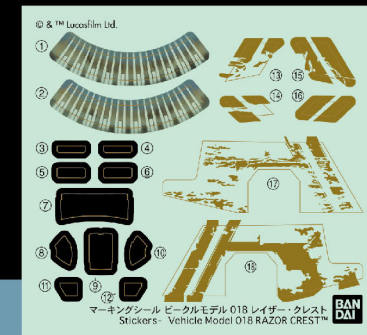

マーキングロケーション Sticker Location

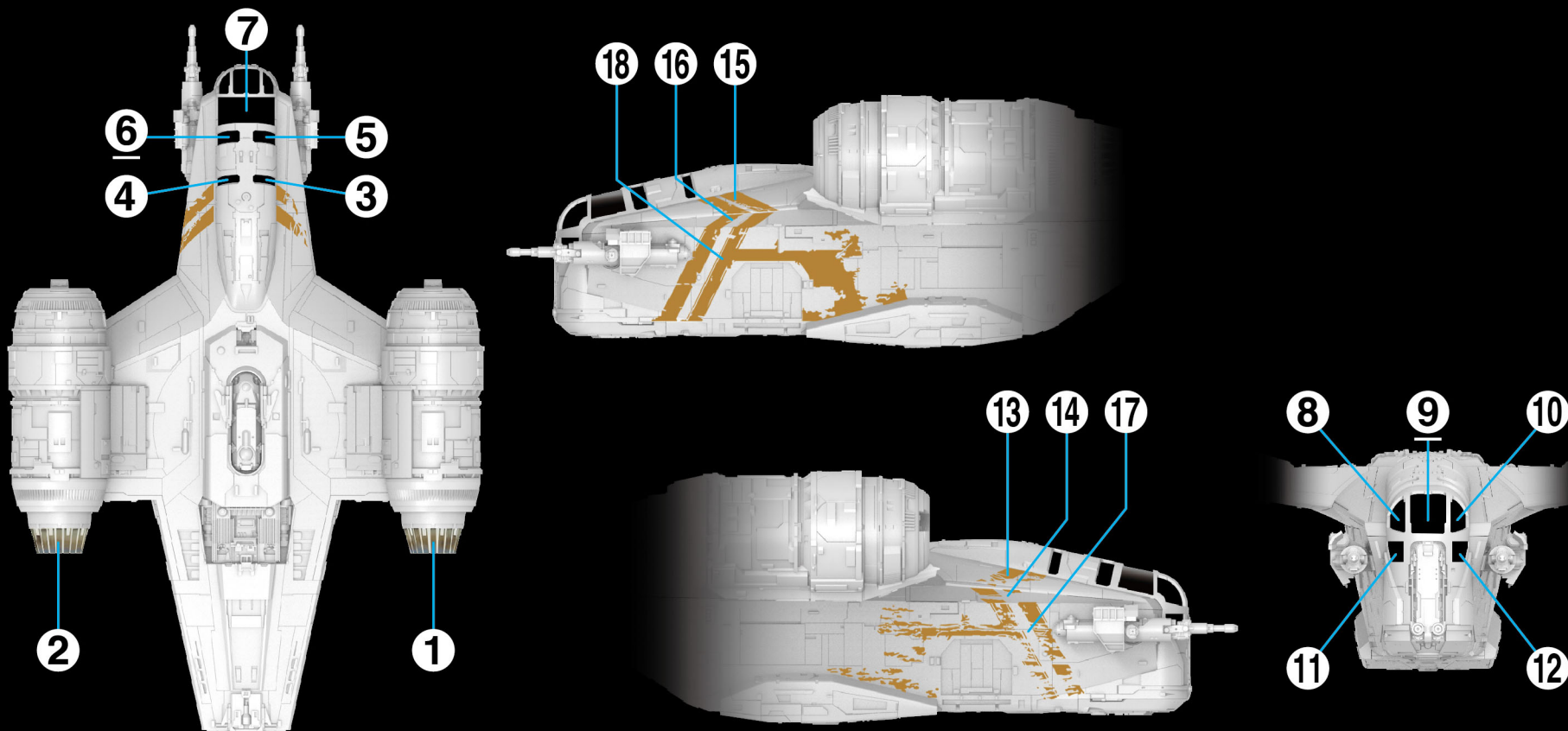

※説明のため、一部画像を省略しています。* For explanatory purposes, some images have been omitted.

● 画像と番号を見て、マーキングシールの貼る位置を確認してください。 ● See the images and numbers for the location of each sticker.

※この商品には、レイザー・クレスト(シルバーコーティングVer.)が1セット入っています。* This package contains one set of RAZOR CREST (SILVER COATING Ver.).

※パッケージの画像と商品とは、多少異なりますのでご了承ください。* The actual product may vary slightly from the images on the package.